

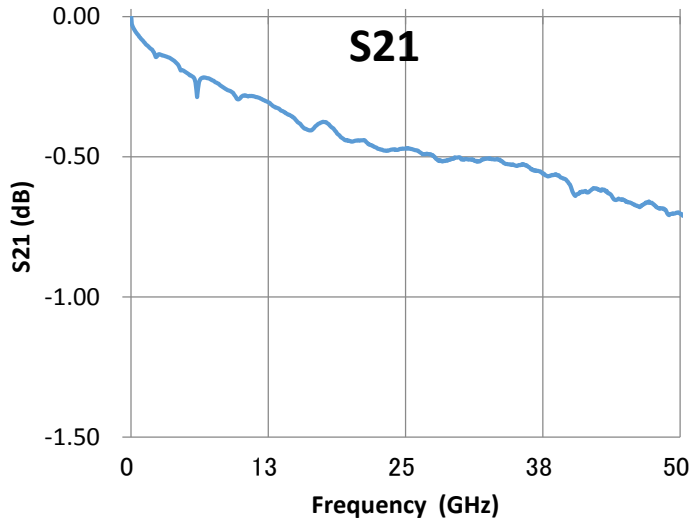

RF Probe Model: TPD50V Series

Typical Insertion Loss (GSGSG-150um pitch)



Electric Performance

Characteristic impedance	50 ohm
Frequency range	DC to 50GHz
Insertion loss (Typ. GSGSG-150μm)	-1.5dB
Return Loss (Typ. GSGSG-150μm)	-15dB
Cross Talk (Typ. GSGSG-150μm)	-35dB
DC voltage	100V
DC current	1A
RF Power @ 10GHz max	5W
Contact resistance on Au	0.05 ohm

Typical Return Loss (GSGSG-150um pitch)

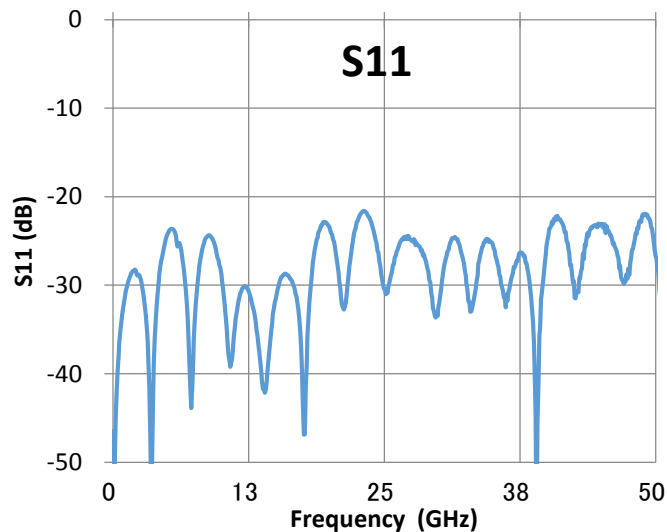

Mechanical Performance

Connector	1.85mm (J)
Available Pitch	50 to 1000μm (25um step)
Available Configuration	GSSG, GSGSG
Probe Material	Nickel Alloy
Body Material	Aluminum Alloy
Contact pressure @2mil Over travel	20g
Contact Cycle (Auto Probe Mode: OD 1mil)	1M
XY position error	Max 10um
Planarity error	Max 10um
Scribing mark (Width)	30um

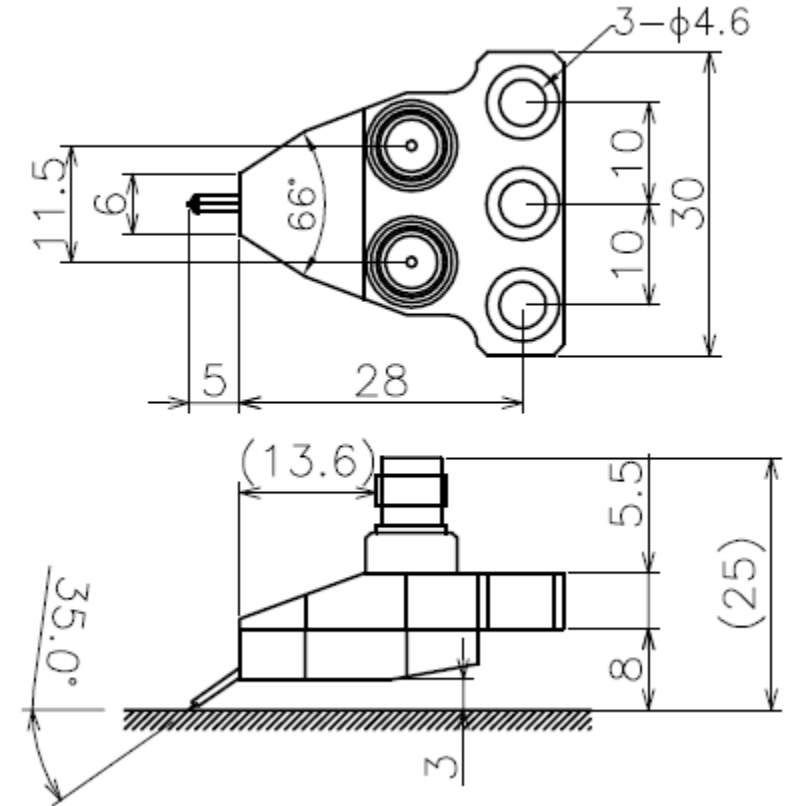

Unit: mm
Tolerance: +/-0.25